

Superstructure
Front Part
CODE 301.0385

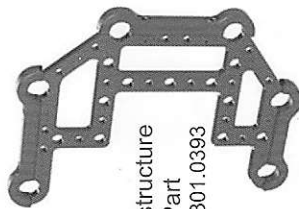

Rod Clamp
CODE 301.0384



Superstructure
Back Part
CODE 301.0393



Slide Part
CODE 301.0392



Tandem Bracket
for Ø15mm/19mm rods
CODE 301.0381



Adapter
for Ø15mm/19mm rods
CODE 301.0380

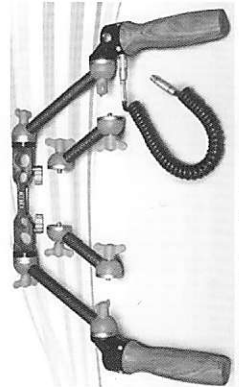

Universal Handle System
CODE 301.0228 (Standard)
CODE 301.0228 (de Luxe)

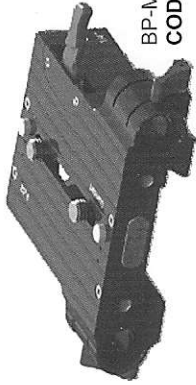

BP-Multi: for using Ø19mm rods
CODE 301.0377



Bridges and Slides for
using Ø19mm rods

CODE 301.0004

CODE 301.0006

CODE 301.0008



FFMini Follow Focus
CODE 301.0088

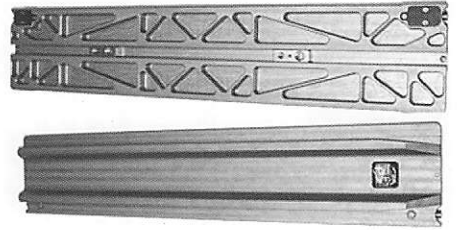

Lens Support Plate, 500mm
CODE 301.0202

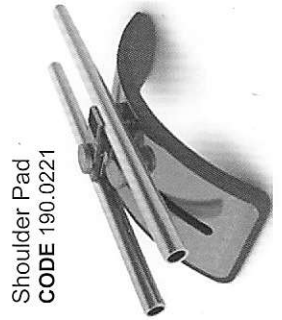

Shoulder Pad
CODE 190.0221

Support Superstructure Accessories

for CANON EOS C300



www.denz-denz.com
info@denz-denz.com
phone +49 89 629 8660

Support

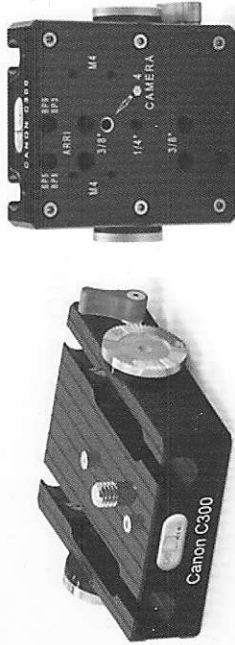

- ▲ The camera is fastened by two centring pins and a 3/8" screw
- ▲ Suitable for Ø15mm rods
- ▲ Left and right rosettes with hirth-serration allow the attachment of handles and more like the DENZ Universal Handle System
- ▲ Made out of highly strengthened aluminium (space technology). The bottom is hard coated and teflon impregnated
- ▲ On the bottom-side a variety of tapped holes enable the usage of the DENZ BP-Multi and bridge plates of other brands
- ▲ The height is adjusted in such a way that any equipment build for the Ø15mm rods can be used, e.g. DENZ FFMini Follow Focus and more
- ▲ Included in delivery: One pair of aluminium rods (Ø15mm, length 240mm)
- ▲ Weight: 390g/0,085lb

CODE 190.0233



www.denz-deniz.com
info@denz-deniz.com
+49 89 629 8660

Superstructure Front Part

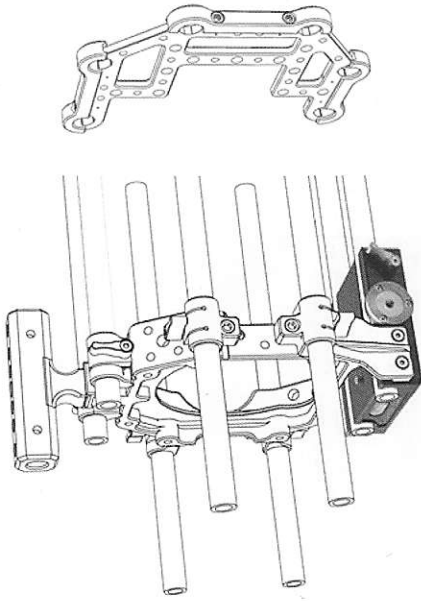

- ▲ The superstructure's **front part** is work out to a thickness of 3mm for perfect stability
- ▲ Two special slots provide for a force-fitted mounting
- ▲ Special handle, detachable, turnable 90°, provides additional mounting options (1/4" and 3/8" screw holes); allows the save and ergonomic handling of the camera
- ▲ Made from Konstruktural aluminium (used in aerospace industry), hard coated, teflon impregnated
- ▲ Included in delivery: Two rod clamps for rods of Ø15mm
- ▲ 28 x 1/4" and 14 x 3/8" screw holes are providing for attaching accessories like a monitor, batteries, recorders, etc.

CODE 301.0385



www.denz-deniz.com
info@denz-deniz.com
+49 89 629 8660

Superstructure Back Part

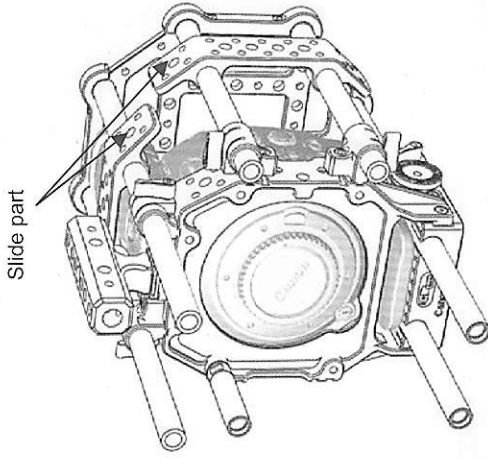

- ▲ The superstructure's **back part** completes support and front part to a cage for a easy mounting on vehicles, helicopters and more
- ▲ A variety of 1/4" and 3/8" tapped holes enable the usage of additional accessories like monitors, batteries, recorders, etc.
- ▲ Made from Konstruktural aluminium (used in aerospace industry), hard coated, teflon impregnated
- ▲ Suitable slide parts with 1/4" and 3/8" tapped holes for additional accessories
- ▲ Suitable Ø15mm rods and the DENZ aluminium end caps with 1/4" and 3/8" threads

CODE 301.0393



www.denz-deniz.com
info@denz-deniz.com
+49 89 629 8660